













Storage Cabinet

LO2/08-22

CONC10	CONC11	DOWEL	GLIDE	SUPPORT	HANDLE	LOCK	TUN220H	SCREW	PLASTIC CAP	
A  Cam Lock Pin 24Pcs+4Pcs	B  Cam Lock 24Pcs+4Pcs	C  Dowel 18Pcs+2Pcs	D  Glide 4Pcs	E  Shelf Support 4Pcs+1Pcs	F  96mm Shape Handle 2Pcs	G  LOCK 1Set	H  Hinge 4Pcs	I  Screw #3*14 6Pcs	J  CAMLOCK CAP 12Pcs+2Pcs	
K  Bumper Plastic 2Each	L  DEEP CAMLOCK CAP 12Pcs+2Pcs	M  Screw M6*40mm 6Pcs	STEP2							

STEP1

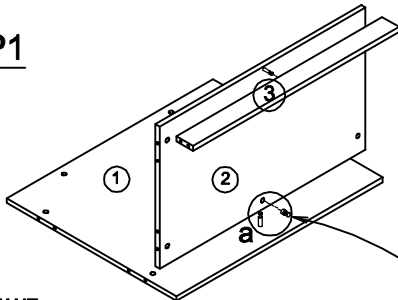

IMPORTANT:

FUNCTION OF CAM



1/4 RIGHT
TURN FOR
LOCKING

MAKE SURE THE ARROW IS POINTING UPWARDS
BEFORE INSERTING INTO THE PANEL'S HOLE.

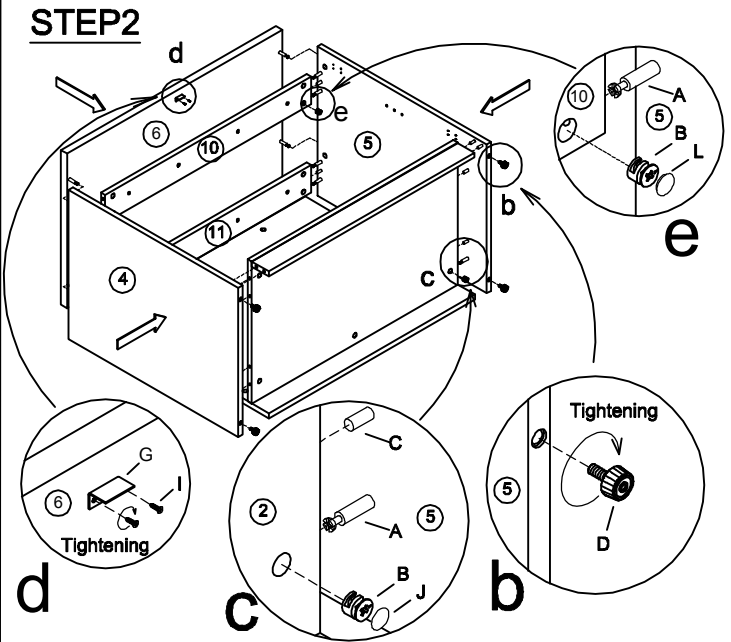
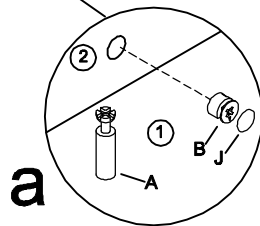

STEP3

Screw M6*40mm 6 Pcs
Remove top panel to attach to top of shell or
freestanding top use 6(m) screws provided, hole
"a1" by used left side, hole "a2" by used right side.

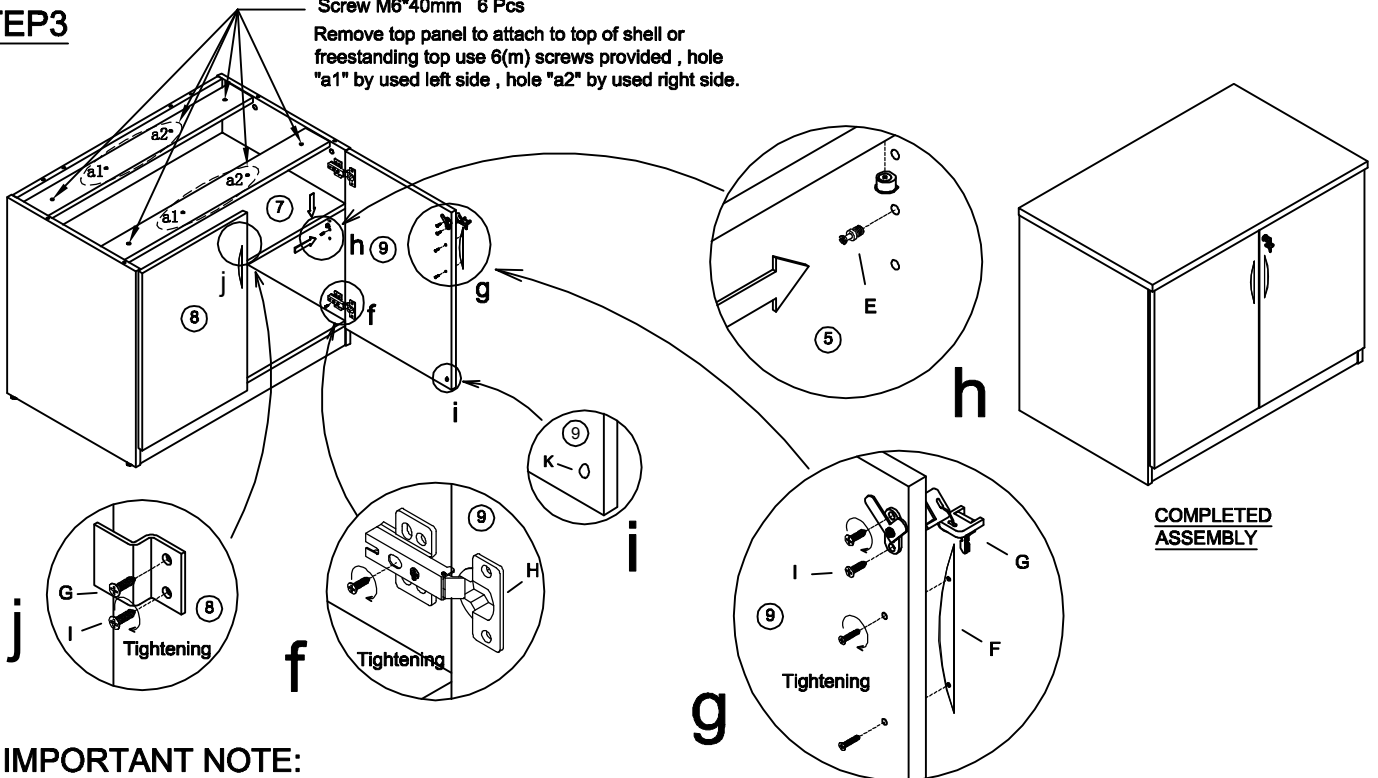

**COMPLETED
ASSEMBLY**

IMPORTANT NOTE:

- It is advisable to assemble unit on a carpet to avoid scratch.
- Check to be sure that you have all parts and hardware.
- Don't tighten all screws/bolts until all completely assembled.
- It is recommended to require 2 persons to complete the assembling.